



SAVE Air Handling Units

Crisp, fresh, and clean air for every home.

[Find more details in our online catalogue](#)



Unlock even greater efficiency

SAVE AHUs come with different heating and cooling recovery methods. Allowing you to further boost the energy efficiency of your units, wherever they're installed.

Performance you can rely on

Our heat exchanger systems automatically regulates the heat/cool recovery and has automatic defrosting functions. Your SAVE AHUs will keep you comfortable inside, no matter the weather on the outside.

For buildings big and small

Whether you're building a new home or renovating an apartment block, SAVE air handling units are a perfect match for any indoor spaces up to 550m².

Health and safety first

SAVE air handling units are Eurovent certified and ErP compliant, easy to service and maintain. So you can relax – knowing the air you breathe is clean and pure.

Full control, from anywhere

All SAVE units come with SAVE Control – multiple, easy-to-use interfaces that let you communicate with your AHUs wherever you are.

Get In Touch

 **Call:** [0845 6880112](tel:08456880112)
 **Email:** info@adremit.co.uk

Our Address

Puravent, Adremit Limited, Unit 5a, Commercial Yard,
Settle, North Yorkshire, BD24 9RH





Certifications



Passive House Institute Certified Component



Eurovent Certified Performance

Get In Touch

 **Call:** [0845 6880112](tel:08456880112)
 **Email:** info@adremit.co.uk

Our Address

Puravent, Adremit Limited, Unit 5a, Commercial Yard,
Settle, North Yorkshire, BD24 9RH







Technical parameters

Unit	
Frequency	50; 60 Hz
Voltage (nominal)	230 V
Phases	1~
Recommended fuse	10 A
Enclosure class	IP24
Speed regulation	Stepless
Product type	Heat recovery unit
Temperature	-20 to 40 °C
Preheater / Reheater	
Input power, reheater	1 kW
Supply fan	
Input power (P1), supply fan	81 W
Supply air filter	
Filter class, supply air	ePM1 60%
Extract air filter	
Filter class, extract air	ePM10 60%
Exchanger	
Heat exchanger rotor drive type	Variable speed
Heat exchanger	Rotating
Return fan / Extract fan	
Input power (P1), extract fan	81 W
Others	
Fan control	Stepless voltage control
Installation type	Vertical
Supply side	Left
Color casing	
Color casing	White
Color casing, RAL	RAL 9010

Article name: SAVE VTR 250/B L 1000W | Product link: <https://shop.systemair.com/en-GB/productPermalink?p=609906> | Item Number: 488823 | Variant: Bag Filters Standard kit | Document type: Product card | Created at: 25.10.2024 | Generated by: Systemair Online Catalogue | Language: English

Get In Touch

 **Call:** 0845 6880112
 **Email:** info@adremit.co.uk

Our Address

Puravent, Adremit Limited, Unit 5a, Commercial Yard, Settle, North Yorkshire, BD24 9RH





Dimensions and weights

Weight 56 kg

ERP

Energy class, Basic unit A

Energy class, Local demand A

ErP ready ErP 2018; ErP 2016

Get In Touch

 **Call:** [0845 6880112](tel:08456880112)
 **Email:** info@adremit.co.uk

Our Address

Puravent, Adremit Limited, Unit 5a, Commercial Yard,
Settle, North Yorkshire, BD24 9RH





Performance

⚠ Recommended low airflow is outside valid range

⚠ Recommended high airflow is outside valid range

Supply - Performance curve

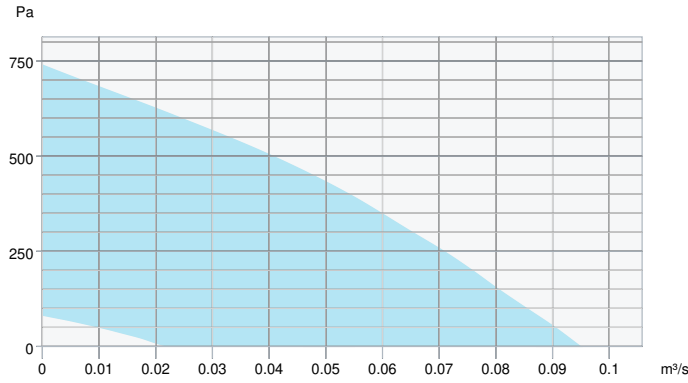

Extract - Performance curve

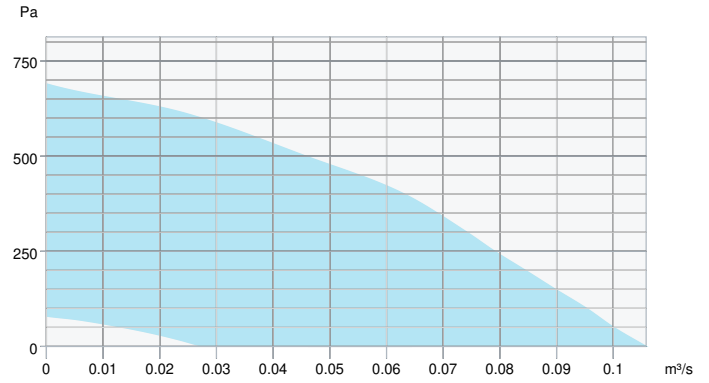

Unit	Supply	Extract
Air density	1.204 kg/m ³	
		Summer Winter
Supply air temperature		- -20.0 °C
Sound pressure level (reverberant field)	Total	

Get In Touch

📞 Call: 0845 6880112
✉ Email: info@adremit.co.uk

Our Address

Puravent, Adremit Limited, Unit 5a, Commercial Yard, Settle, North Yorkshire, BD24 9RH







Ecodesign

Product		
Trade name	Systemair	
Product name	SAVE VTR 250/B L 1000W	
Basic unit		
ErP compliance	2018	
SEC Average	-35.6	kWh/(m ² .a)
SEC Cold	-77.5	kWh/(m ² .a)
SEC Warm	-11.5	kWh/(m ² .a)
SEC Class	A	
Unit category	RVU	
Unit type	BVU	
Drive	Integrated VSD	
Heat recovery type	Regenerative	
Temperature ratio	81	%
qv max	307	m ³ /h
P max	167	W
Sound power (LWA)	38	dB(A)
qv ref	0.06	m ³ /s
Ps ref	50	Pa
SPI	0.367	W/(m ³ /h)
CTRL	0.85	
MISC	1.1	
x-value	2	
External Leakage	3	%
Internal Leakage	Not applicable	
Carry over	4	%
Type of product	RAHU/AARE	
AEC average	332	kWh/a
AEC cold	332	kWh/a
AEC warm	332	kWh/a
AHS Average	4,386	kWh/a
AHS Cold	8,580	kWh/a
AHS Warm	1,983	kWh/a

Article name: SAVE VTR 250/B L 1000W | Product link: <https://shop.systemair.com/en-GB/productPermalink?p=609906> | Item Number: 488823 | Variant: Bag Filters Standard kit | Document type: Product card | Created at: 25.10.2024 | Generated by: Systemair Online Catalogue | Language: English

Get In Touch

 **Call:** 0845 6880112
 **Email:** info@adremit.co.uk

Our Address

Puravent, Adremit Limited, Unit 5a, Commercial Yard,
 Settle, North Yorkshire, BD24 9RH





Units with local demand control		
ErP compliance		2018
SEC Average	-40.2	kWh/(m ² .a)
SEC Cold	-83.3	kWh/(m ² .a)
SEC Warm	-15.5	kWh/(m ² .a)
SEC Class		A
Unit category		RVU
Unit type		BVU
Drive		Integrated VSD
Heat recovery type		Regenerative
Temperature ratio	81	%
qv max	307	m ³ /h
P max	167	W
Sound power (LWA)	38	dB(A)
qv ref	0.06	m ³ /s
Ps ref	50	Pa
SPI	0.367	W/(m ³ /h)
CTRL	0.65	
MISC	1.1	
x-value	2	
External Leakage	3	%
Internal Leakage		Not applicable
Carry over	4	%
Type of product		RAHU/AARE
AEC average	195	kWh/a
AEC cold	194	kWh/a
AEC warm	194	kWh/a
AHS Average	4,507	kWh/a
AHS Cold	8,817	kWh/a
AHS Warm	2,038	kWh/a

Get In Touch

 **Call:** 0845 6880112
 **Email:** info@adremit.co.uk

Our Address

Puravent, Adremit Limited, Unit 5a, Commercial Yard, Settle, North Yorkshire, BD24 9RH





Dimension

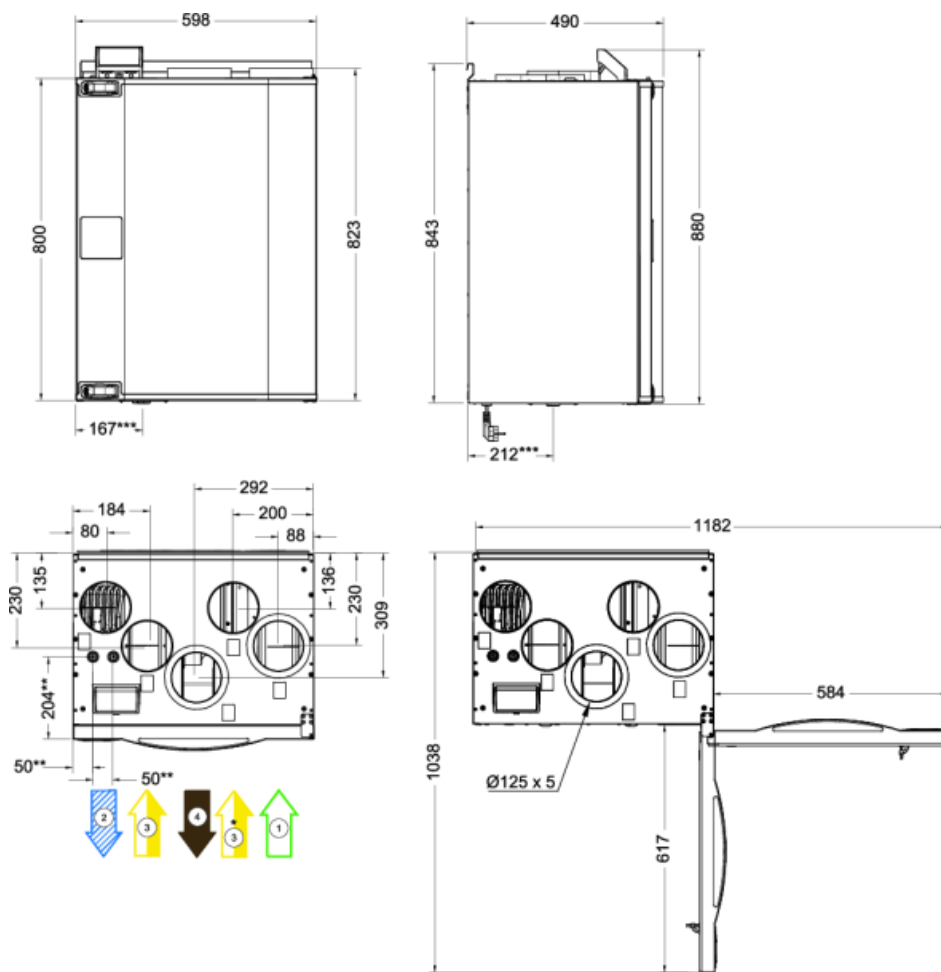

* Cooker hood connection

** Water battery connections

*** Drainage connection

Get In Touch

Call: 0845 6880112
Email: info@adremit.co.uk

Our Address

Puravent, Adremit Limited, Unit 5a, Commercial Yard, Settle, North Yorkshire, BD24 9RH





- 1 Outdoor air
- 2 Supply air
- 3 Extract air
- 4 Exhaust air

Get In Touch



Call: [0845 6880112](tel:08456880112)



Email: info@adremit.co.uk

Our Address

Puravent, Adremit Limited, Unit 5a, Commercial Yard,
Settle, North Yorkshire, BD24 9RH





Energy class label

Energy class, Basic unit

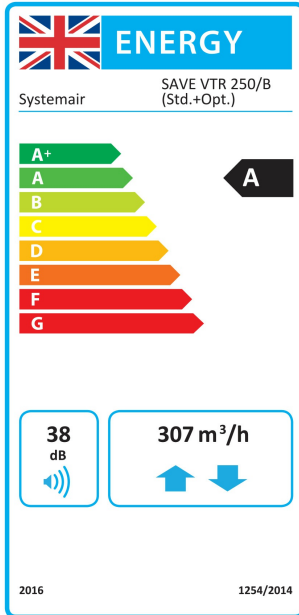

Get In Touch

Call: 0845 6880112
Email: info@adremit.co.uk

Our Address

Puravent, Adremit Limited, Unit 5a, Commercial Yard,
Settle, North Yorkshire, BD24 9RH





Accessories

- SAVE CONNECT 2.0 (399999)
- SAVE LIGHT White (319118)
- SAVE TOUCH White (138077)
- Duct Cover White VTR 250/B (156360)
- Pressure guard with pitot tube (212987)
- RMK (153549)
- SAVE Wall Mounted Kit (140736)
- Systemair-E CO2 sensor (14904)
- VBC 125-3 Water heating batt (9839)
- CB 125-1,2 230V/1 Duct heater (5290)
- CEC Cable w/plug 12m (24782)
- CEC Cable w/plug 6m (24783)
- Duct sensor -30-70C (211524)
- LDC 125-600 Silencer (5190)
- Surface sensor -30-150C (211523)
- 392-10/B Slimline White (77265)
- 602-10/B Cookerhood White (47561)
- 722-10/B TENDER Wall 600 white (78978)
- 762-10/B OPAL Wall 600 steel (78970)
- 772-10/B OPAL Free 900 steel (78972)
- 782-10/B STIL Wall 900 steel (78974)
- Ceiling Mounting kit VTR250L (151640)
- CVVX 125 Combi grille, black (26421)
- MONOLIT - B S.Steel (326801)
- Room sensor 0-50C (211525)
- SPI-125 C Iris damper (6751)
- TUNE-R-125-3-M2 (311948)
- TUNE-R-125-3-M5 (311978)
- ZTR 15-0,4 valve 3-way (9670)
- ZTV 15-0,4 2-way valve (9829)
- SAVE LIGHT Black (319119)
- SAVE TOUCH Black (138078)
- CB heater connection kit 1 ~ (142852)
- Presence detector/IR24-P (6995)
- PSS20 Transformer 24V (202692)
- RMK-T (153548)
- Systemair-E CO2 RH Temperature (211522)
- VAV/CAV conversion kit (140777)
- CB 125-0,6 230V/1 Duct heater (5289)
- CB 125-1,8 230V/1 Duct heater (5377)
- CEC Cable w/plug 15m (306594)
- CWK 125-3-2,5 Duct cooler,circ (30021)
- FK 125 Fast clamp (1608)
- LDC 125-900 Silencer (5191)
- VBC 125-2 Water heating batt (5457)
- 602-10/B Cookerhood S.Steel (47562)
- 722-10/B TENDER Wall 600 steel (78976)
- 722-10/B TENDER Wall 900 steel (78977)
- 762-10/B OPAL Wall 900 steel (78971)
- 782-10/B STIL Wall 600 steel (78973)
- 792-10/B STIL Free 900 steel (78975)
- Ceiling Mounting kit VTR250R (151641)
- CVVX 125 Combi grille, white (26422)
- MONOLIT - B White (326800)
- RVAZ4 24A Actuator 0-10V (9862)
- TUNE-R-125-3-M1 (311938)
- TUNE-R-125-3-M4 (311968)
- USB-Nano-485 (282047)
- ZTR 15-0,6 valve 3-way (6573)
- ZTV 15-0,6 2-way valve (6571)

Documents

- Control panel installation quick guide
- Energy label placement quick guide
- Installation manual
- Installation manual SAVE CONNECT 2.0
- Modbus variable list
- Service and Accessories installation manual
- SYSTEMAIR_SAVE_VTR_250_DISASSEMBLY_GUIDE_EN_SE_DE_NO_FI_20181207.PDF
- User manual
- Certificate Passive House Institute - SAVE VTR 250
- Eurovent Certification Diploma
- Commissioning record
- Technical fiche
- Schematic layout and description of components
- UK Declaration of Conformity
- Electrical diagrams for accessories
- Wiring diagram

Get In Touch

- Call: 0845 6880112
- Email: info@adremit.co.uk

Our Address

Puravent, Adremit Limited, Unit 5a, Commercial Yard,
Settle, North Yorkshire, BD24 9RH