



ENJOY



CASE STUDY:



Save 63% on the gas consumption for your tunnel washers. Here's how CWS Workwear in Den Bosch, Netherlands did it.

2024-05-06

Get In Touch

Call: [0845 6880112](tel:08456880112)
Email: info@adremit.co.uk

Our Address

Puravent, Adremit Limited, Unit 5a, Commercial Yard, Settle, North Yorkshire, BD24 9RH





01





EXECUTIVE SUMMARY

In the early summer of 2023, the management team at CWS Workwear in Den Bosch, Netherlands, initiated what the team considered a high-risk/high-potential trial – a new generation heat exchanger developed in Sweden was deployed to test if it could withstand the toughest challenge in industrial laundry – the finisher.

Prior to the test, the air that generally has a temperature of around 80°C and is very moist, was released straight out into the ambient air, without heat recovery.

The test added the heat recovery technology to the exhaust from the finisher, and the recovered thermal energy was used to pre-heat the process water used by the two tunnel washers on site.

Get In Touch

 Call: [0845 6880112](tel:08456880112)
 Email: info@adremit.co.uk

Our Address

Puravent, Adremit Limited, Unit 5a, Commercial Yard,
Settle, North Yorkshire, BD24 9RH



HIGHLIGHTS

02

The test was scheduled to run over six months to confirm both energy recovery performance and provide enough data to decide upon required cleaning intervals.

From day one, it was clear that the energy recovery was efficient and over the course of the trial, the figures were confirmed:

-At the completion of the trial, for the two tunnel washers, the total saving on gas was 63%.

-The saving was measured on a kilowatt hour of gas per kilogram of laundry (kWh/kg) basis.

-At the evaluation point, the usage of gas per weight of laundry had decreased from 0,019 kWh/kg, down to 0,007 kWh/kg.

-Over the first full year, the resulting decrease of fossil CO2 emissions for the site will be 50 tons

The trial also showed that the energy savings were connected to the frequency of cleaning, and though the trial showed that the heat exchanger could operate under a regime where it was cleaned every three months, the management team decided – in the interest of maximizing savings – to deploy a monthly cleaning schedule.

The decision balanced the maximized gas savings and the cost of cleaning, as the cleaning every month requires about half an hour of staff time.

Get In Touch

 **Call:** [0845 6880112](tel:08456880112)
 **Email:** info@adremit.co.uk

Our Address

Puravent, Adremit Limited, Unit 5a, Commercial Yard,
Settle, North Yorkshire, BD24 9RH

THE BACKGROUND

03



At CWS Workwear in s'Hertogenbosch, better known outside of the Netherlands as Den Bosch, the team has worked very actively over the last years to find and implement new technologies to increase energy efficiency and lower carbon emissions, which is in line with the overall CWS Workwear sustainability strategy. In spring 2023, the installation of rooftop solar PV was finalized and prior to that many other projects had been completed.

It has long been well known that the release of the warm exhaust air from the finishers, drying tumblers and flat ironers, without it passing through any heat recovery equipment, represents a huge waste of thermal energy. But there really hasn't been any viable technical solution available.



CWS Workwear had run trials where standard heat exchangers had been deployed to try to recover the inherent thermal energy from the exhaust process ventilation, but none of these trials were successful. The lint, wax and residual oils clogged the heat exchangers for some of the trials after only a few hours of operation.

Get In Touch

 Call: [0845 6880112](tel:08456880112)
 Email: info@adremit.co.uk

Our Address

Puravent, Adremit Limited, Unit 5a, Commercial Yard,
Settle, North Yorkshire, BD24 9RH

THE PROJECT

04

In the early summer of 2023, the CWS Workwear management team at the site decided they were ready for another attempt at stopping the heat loss and they initiated what they considered a high-risk/high-potential trial – a new generation heat exchanger, the Lepido, developed in Sweden, had shown robust energy saving results in several applications in restaurant ventilation, cutting large parts of the energy consumption for vital operations.

After long discussions and preparations together with the supplier from Sweden, the team decided to trial if the technology could successfully make the transition from restaurant ventilation into the altogether much more troublesome environment of industrial laundry ventilation.

The team decided to go for the toughest challenge – the finisher – where the warm exhaust air does not go through any integrated filtration unit before it reaches the extract process ventilation system. Currently the air that generally has a temperature of around 80°C and is very moist, is released straight out into the ambient air.

The trial was initiated with the hope that the waste heat from the finisher could finally be recovered and used to reduce the consumption of gas used to heat the process water for the two tunnel washers.

Get In Touch



Call: [0845 6880112](tel:08456880112)



Email: info@adremit.co.uk

Our Address

Puravent, Adremit Limited, Unit 5a, Commercial Yard,
Settle, North Yorkshire, BD24 9RH

THE SOLUTION

05

The team wanted to challenge the Lepido to the maximum, arguing that “if it can function robustly in the toughest environment – the finisher – then, if the trial is successful, we know that we could also deploy the heat exchanger in our drying tumblers and flat-ironers to recover the energy there as well”.

The technical team knew already at the outset that they wanted to use the captured thermal energy to pre-heat the process water used by the two tunnel washers on site. They had already installed grey water heat exchangers on the tunnel washers to improve energy efficiency, but the process water could, in a perfect world, be pre-heated all the way up to 45°C using recovered heat from the current waste heat from the finisher exhaust.

The final technical solution was to deploy two Lepidos, one on the exhaust ventilation for the Inlet-zone part of the finisher and one on the exhaust ventilation for the Outlet-zone part of the finisher. The exhaust air in both these ventilation ducts holds a temperature of about 80°C and contains a lot of moisture, as a result of the drying process.

The captured thermal heat is transferred to the tunnel washer system, where it is introduced at a point prior to when the water reaches the steam heater. This allows for any recaptured energy from the finisher exhaust air to be re-introduced into the process water for the tunnel washers and increasing the temperature of the water for free, which means less steam will be used to heat the water.





**One of two Lepidos
installed at CWS Workwear**

CWS

WORKWEAR

Get In Touch

 **Call:** [0845 6880112](tel:08456880112)
 **Email:** info@adremit.co.uk

Our Address

Puravent, Adremit Limited, Unit 5a, Commercial Yard,
Settle, North Yorkshire, BD24 9RH

THE RESULT

06

On a more detailed technical level, as shown in the flow chart, the thermal heat from the Lepido is re-introduced either directly into the flowing water when the tunnel washers are demanding new process water, or it is diverted into the accumulator tank for pre-heated process water, at those points of the washing cycle when the tunnel washer is not demanding any process water. This allows for the Lepido to deliver recaptured energy constantly, regardless of which phase the tunnel washer program currently is at.

The trial was designed to test three main points:

- 1) Confirm that the installation delivers recovered energy at the levels that the software simulation prior to the project indicated, with a discrepancy of +/-10%.
- 2) Provide solid data to decide on how often the Lepido should be cleaned.
- 3) Confirm the economics for both savings as in point 1 above and for the trial budget cost

To ensure data availability to evaluate all points above, a plethora of control and measurement equipment was installed. The data was made available to all participants via remote access log-in.

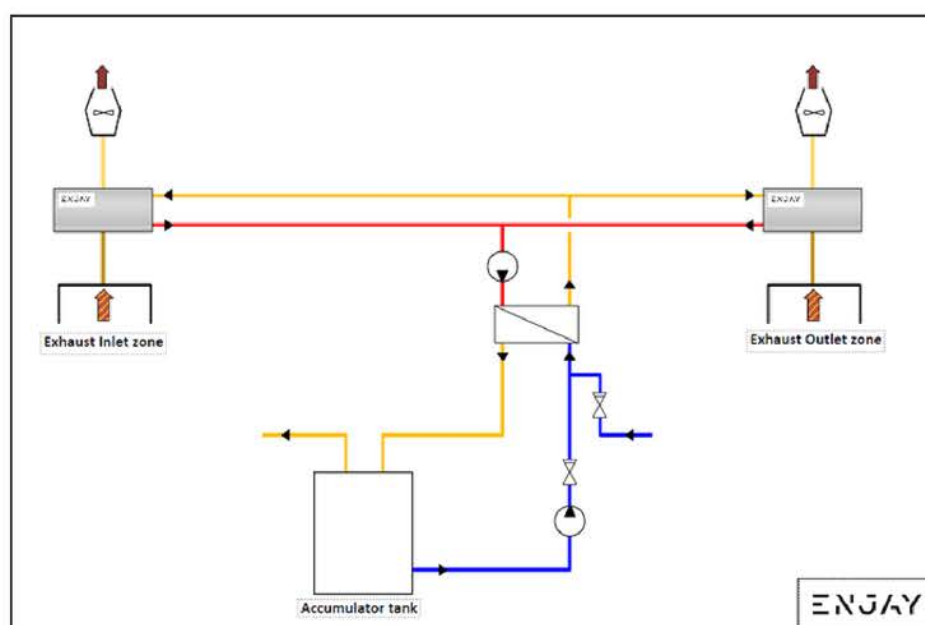

Get In Touch

Call: 0845 6880112
Email: info@adremit.co.uk

Our Address

Puravent, Adremit Limited, Unit 5a, Commercial Yard,
Settle, North Yorkshire, BD24 9RH



THE RESULT

07



From the first day of operation for the trial, it was immediately apparent that the Lepidos delivered a significant saving on energy consumption. The below exhibit X shows the average weekly gas consumption in m³ for the tunnel washers during the four weeks before the trial and during the first four weeks after the trial was initiated.

As can be seen in Exhibit X, the average saving on gas use for the two tunnel washers was 55% at this point of the trial. Although these gas consumption figures did not take into account the number of tons washed, 55% savings were significant.

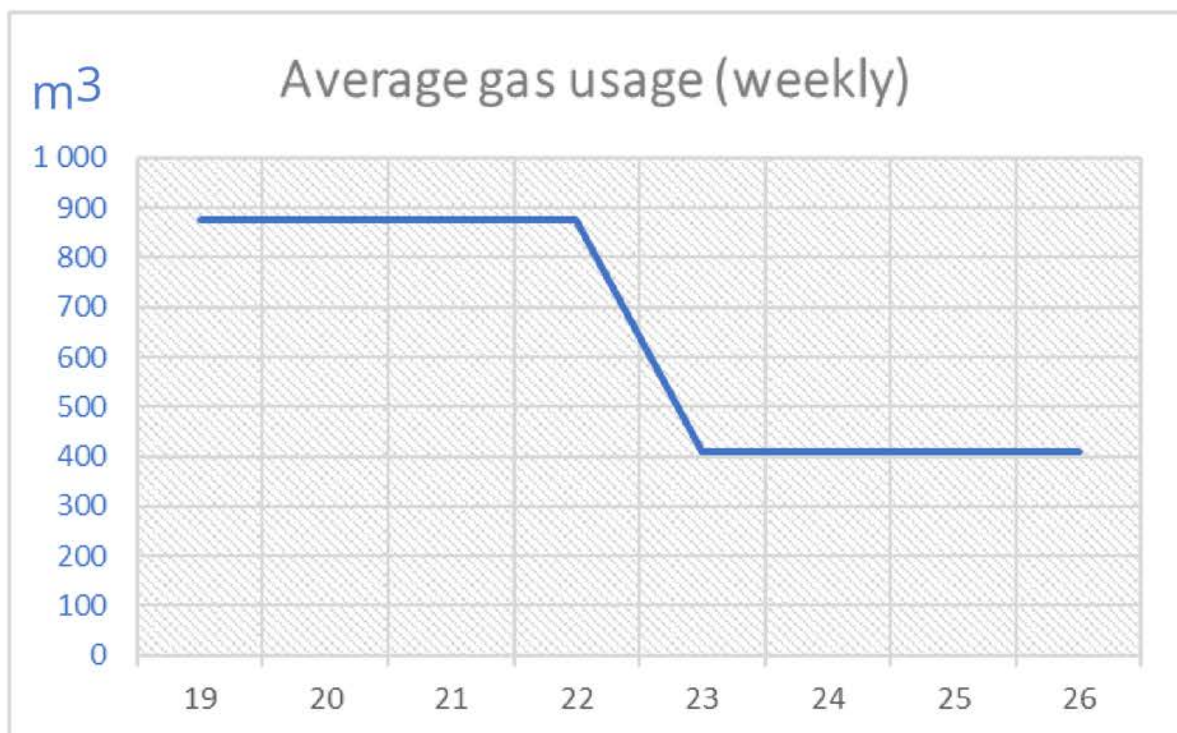
Exhibit X: Average gas consumption for the tunnel washers four weeks before and four weeks after trial start



Get In Touch

 Call: [0845 6880112](tel:08456880112)
 Email: info@adremit.co.uk

Our Address

Puravent, Adremit Limited, Unit 5a, Commercial Yard,
Settle, North Yorkshire, BD24 9RH



THE RESULT

08

As the trial progressed and as the full installation of all the designed parts were completed, including the loop of recovered energy into the accumulator tank, the saving increased further from the average 55% at the beginning of the trial. At the end of the trial, the data was evaluated according to the three main points above, and all were given the green light.

1) Confirm delivered recovered energy

At the conclusion of the trial, the differences in gas consumption could be combined with the production figures to produce an understanding of the total saving of gas per produced kg of laundry for the two tunnel washers. This measurement allows for a fair evaluation of the actual energy delivery from the heat recovery process on a comparable basis.

The result was astonishing: The figures for average gas usage in kilowatt hour per produced kg of laundry (kWh/kg) are shown in Exhibit Y:

Exhibit Y – gas consumption for heating the process water for the two tunnel washers per produced kilogram of laundry:	
Prior to the trial	0,019 kWh/kg
At the end of the trial	0,007 kWh/kg
General gas usage decrease	-63%

Get In Touch

Call: [0845 6880112](tel:08456880112)
Email: info@adremit.co.uk

Our Address

Puravent, Adremit Limited, Unit 5a, Commercial Yard, Settle, North Yorkshire, BD24 9RH

THE RESULT

09

2) Decide on cleaning cycle

The trial showed that the Lepidos would deliver according to the simulated energy savings even if the system was cleaned only once every three months. But, as the savings were more than 25% better than simulated if the Lepidos were cleaned once every month – and the cost for cleaning only amounted to one maintenance staff utilizing 30 minutes once a month – it was decided that **the cleaning cycle will be once every month.**



3) Trial economics

As the savings were confirmed in point 1, that side of the equation was already confirmed. The other side of the equation, the cost side, was also confirmed to have stayed **within the quoted budget.**

Energy savings also translate directly into savings in fossil CO2 emissions. By finally finding a way to recapture the waste heat from the different hot processes in the laundry operations, it is now possible to significantly reduce the carbon footprint as well. The heat recovery from the finisher in Den Bosch will save considerably more than 50 tons of fossil CO2 annually, and it will do so while considerably reducing the gas bill.

And, the investment in the heat recovery equipment will pay back in less than three years.

Get In Touch

 Call: [0845 6880112](tel:08456880112)
 Email: info@adremit.co.uk

Our Address

Puravent, Adremit Limited, Unit 5a, Commercial Yard,
Settle, North Yorkshire, BD24 9RH



THE CONCLUSION

10

All three major points from the trial were deemed to have been fulfilled. Energy savings, cleaning cycle requirements and economics, all passed.



The team concluded that **the 63% savings on gas consumption for heating the process water for the two tunnel washers was an astonishing result.** And, diving a bit deeper into the figures, there is not a lot more that could be done on the water side of the tunnel washers: You don't want to pre-heat the process water to more than 45°C as this is the maximum inlet temperature. And with the Lepido installed and with the installation of the loop into the accumulator tank of process water finalized, the integrated gas burners in the tank, which are programmed to keep the water temperature in the tank at 45°C, are barely operating.

This means that the Lepido circuit manages to keep the pre-heat temperature of the process water close to 45°C, using only recovered thermal energy from the finisher process.

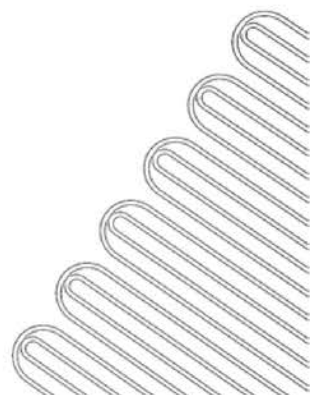
So there is not much room for further improvement on the thermal energy consumption for the process water for the two tunnel washers.



Get In Touch

 **Call:** [0845 6880112](tel:08456880112)
 **Email:** info@adremit.co.uk

Our Address

Puravent, Adremit Limited, Unit 5a, Commercial Yard,
Settle, North Yorkshire, BD24 9RH



THE CONCLUSION

11

All of the above was achieved by using only the waste heat from one (1) finisher. And, as the finisher is the toughest challenge when it comes to particles in laundry ventilation, as it deploys no internal filters in the machine – all the lint goes straight up to the Lepido units – the team also concluded that there is ample opportunity to look at the deployment of Lepido for the other warm exhaust air flows on site. The waste heat from drying tumblers can be used as a direct feedback loop to pre-heat the fresh air which is added during each drying cycle. The team will proceed to evaluate how much energy can be saved by deploying Lepido in the exhaust ventilation system from drying tumblers and flat-ironers.

As a very crude first ball-park figure, the CWS Workwear Den Bosch site seems to be able to save more than 250 tons of fossil CO2 once all available heat sources have been tapped for heat recovery. Though not confirmed, this figure is still very encouraging, especially since it will be the direct result of a significant reduction in operating cost.

The team concluded that the 63% savings on gas consumption for heating the process water for the two tunnel washers is an astonishing result.

Get In Touch

 **Call:** [0845 6880112](tel:08456880112)
 **Email:** info@adremit.co.uk

Our Address

Puravent, Adremit Limited, Unit 5a, Commercial Yard,
Settle, North Yorkshire, BD24 9RH



LEPIDO BY ENJAY

Lepido is an Innovated & Made in Sweden air-to-fluid heat exchanger, specially designed to be deployed in polluted air streams. It is developed for mounting in the duct, without any requirement for pre-filtration.

Contrary to a standard heat exchanger, where the natural forces constantly work against keeping the unit clean, the Lepido interior is designed to work with the natural forces. It involves a geometry that is fin-less design and allows for more spacing than a traditional heat exchanger.

For more information about Lepido: [Product Brochure](#)

FIVE GUYS



CWS

WORKWEAR

Get In Touch

 Call: [0845 6880112](tel:08456880112)
 Email: info@adremit.co.uk

Our Address

Puravent, Adremit Limited, Unit 5a, Commercial Yard,
Settle, North Yorkshire, BD24 9RH



For any questions or enquiries, please contact us:



Derbyvägen 20, 212 35, Malmoe Sweden



+46 4012 33 30



www.enjaysystems.com



enquiries@enjaysystems.com

ENJAY

Get In Touch



Call: [0845 6880112](tel:08456880112)



Email: info@adremit.co.uk

Our Address

Puravent, Adremit Limited, Unit 5a, Commercial Yard,
Settle, North Yorkshire, BD24 9RH



ABOUT CWS WORKWEAR

Founded in 1899, CWS Workwear has been dedicated to serving customers to protect their workers and the planet for 125 years. We are a leader in the workwear industry providing "Workwear as a Service" with customised, stylish, long-lasting and protective workwear, encompassing more than a century of innovation and service.

Embracing a circular business model, we are committed to creating a sustainable and resilient future, marking our position as a leader in the workwear industry with an European presence. Our operations span 15 countries with a dedicated team of 5,300 professionals across 103 locations. Our infrastructure includes 33 state-of-the-art industrial laundries in Europe.

We take pride in our extensive customer base, serving more than 35,000 customers across all workwear markets and providing 1.5 million individuals every day with our service. Leveraging our local presence, we thrive for a close and local partnership with our customers.



Our commitment to sustainability is at the heart of everything we do, guided by an ambitious roadmap aimed at reducing both our own and our customers' CO2 emissions. By fostering a 360° customer experience and maintaining proximity to our clients, we ensure our workwear solutions meet specific needs, support responsible production practices and significantly reduce carbon footprints.

"Work your style. For you, for your business, for the planet." Join us as we continue to innovate and commit to our customers, fostering a safer, more sustainable world for generations to come.

More information: www.cws.com/workwear

**CWS****WORKWEAR**

Get In Touch

 **Call:** 0845 6880112
 **Email:** info@adremit.co.uk

Our Address

Puravent, Adremit Limited, Unit 5a, Commercial Yard,
Settle, North Yorkshire, BD24 9RH