

RAV 800 ROOF COWL

Item no. 8491

Document type: **Product card**

Document date: **2019-06-25**

Generated by: **Systemair Online Catalogue**

Description

The RAV vertical discharge roof cowl is manufactured from UV stabilised glass reinforced polyester to ensure a rigid, lightweight, corrosion-free, weather resistant unit. Can be used purely as a terminal or combined with a ZSP or ZAP plate axial fan to create a powered extract/supply unit.

Coloured to BS 00 A 05 goosewing grey as standard, but available in any BS or RAL colour if required.

All RAV cowls are supplied fitted with backdraught shutters.



Accessories

Accessories

[SKR 800 RA soaker sheet \(8464\)](#)

[PB 800 Purlin Box \(8698\)](#)

Dimensions

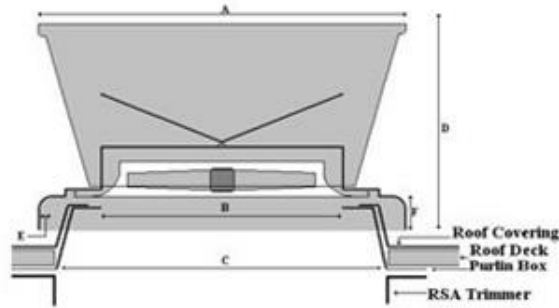

UNIT REF	A Weather Cowl sq	B Purlin box Aperture	C Purlin box base/ Roof aperture	D Unit height	E Weatherskirt Base sq	F Base Downstand	Weight Kg **
RAV315	690	400	680	475	520/555	100	8.5
RAV350	690	400	680	475	660/695	100	8.5
RAV400	790	510	780	585	755/795	100	12
RAV450	790	510	780	585	755/795	100	12
RAV500	950	620	910	700	920/960	110	21
RAV560	950	620	910	700	920/960	110	21
RAV630	1030	780	950	800	1010/1055	110	27
RAV800	1130	910	1150	750	1125/1170	110	34

*All dimensions indicated are nominal and subject to design change. The right to alter specification is reserved.

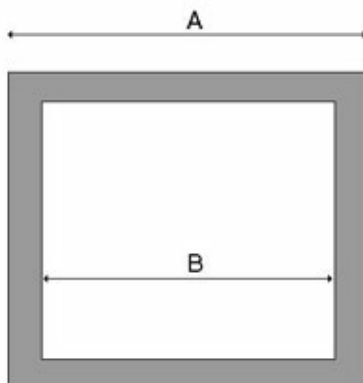

UNIT REF	A External	B internal	Suggested Min curb - mm
RA 200	425	225	100
RA 250	425	275	75
RA 315	500	350	75
RA 350	590	390	100
RA 400	700	450	125
RA 450	700	500	100
RA 500	870	570	150
RA 560	870	620	125
RA 630	990	690	150
RA 710	990	790	100
RA 800	1090	890	100
RA 1000	1325	1075	125

Documentation

 RAW_RAV O&M.pdf (15,52kB)

Specification text