

RSK-150 BACK DRAFT DAMPER

Item no. 5599

Document type: **Product card**

Document date: **2019-06-24**

Generated by: **Systemair Online Catalogue**

Description

Back draft damper for circular ducts, manufactured from galvanised sheet steel. The two blades are spring-loaded, which means that the damper can also be mounted vertically.



Dimensions

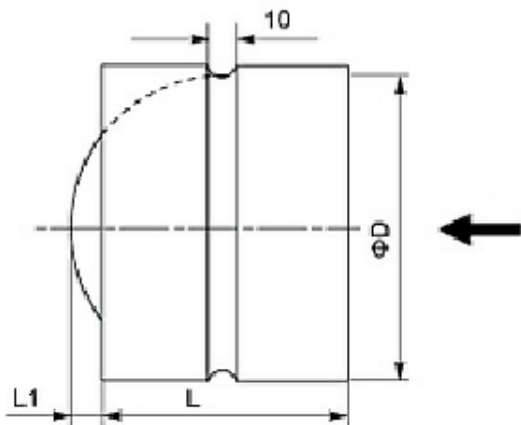

	ØD	L1	L
RSK 100	99	5	90
RSK 125	124	18	90
RSK 150	149	30	90
RSK 160	159	35	90
RSK 200	199	55	90
RSK 250	249	62,5	125
RSK 315	314	95,5	125
RSK 355	354	115	125
RSK 400	399	137,5	125

Documentation

 [EC Declaration of conformity RSK EN-DE.pdf \(72,01kB\)](#)

Diagram

