

## RSK-630 BACK DRAFT DMP.

Item no. 9770

Document type: **Product card**

Document date: **2019-06-24**

Generated by: **Systemair Online Catalogue**

### Description

Back draft damper for circular ducts, manufactured from galvanised sheet steel. The two blades are spring-loaded, which means that the damper can also be mounted vertically.



### Dimensions

	ØA	D	B	C
RSK 450	450	247	75	75
RSK 500	500	247	75	75
RSK 560	560	247	75	75
RSK 630	630	247	75	75

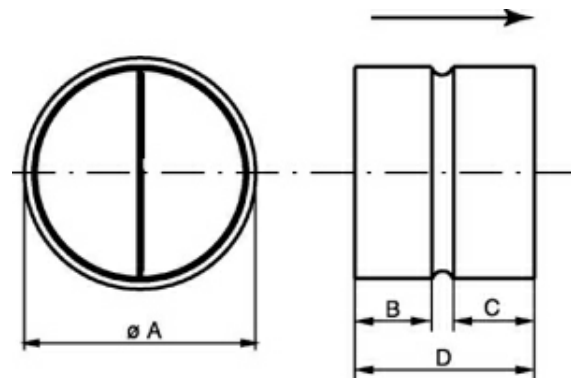

### Documentation

 [EC Declaration of conformity RSK EN-DE.pdf \(72,01kB\)](#)

Diagram

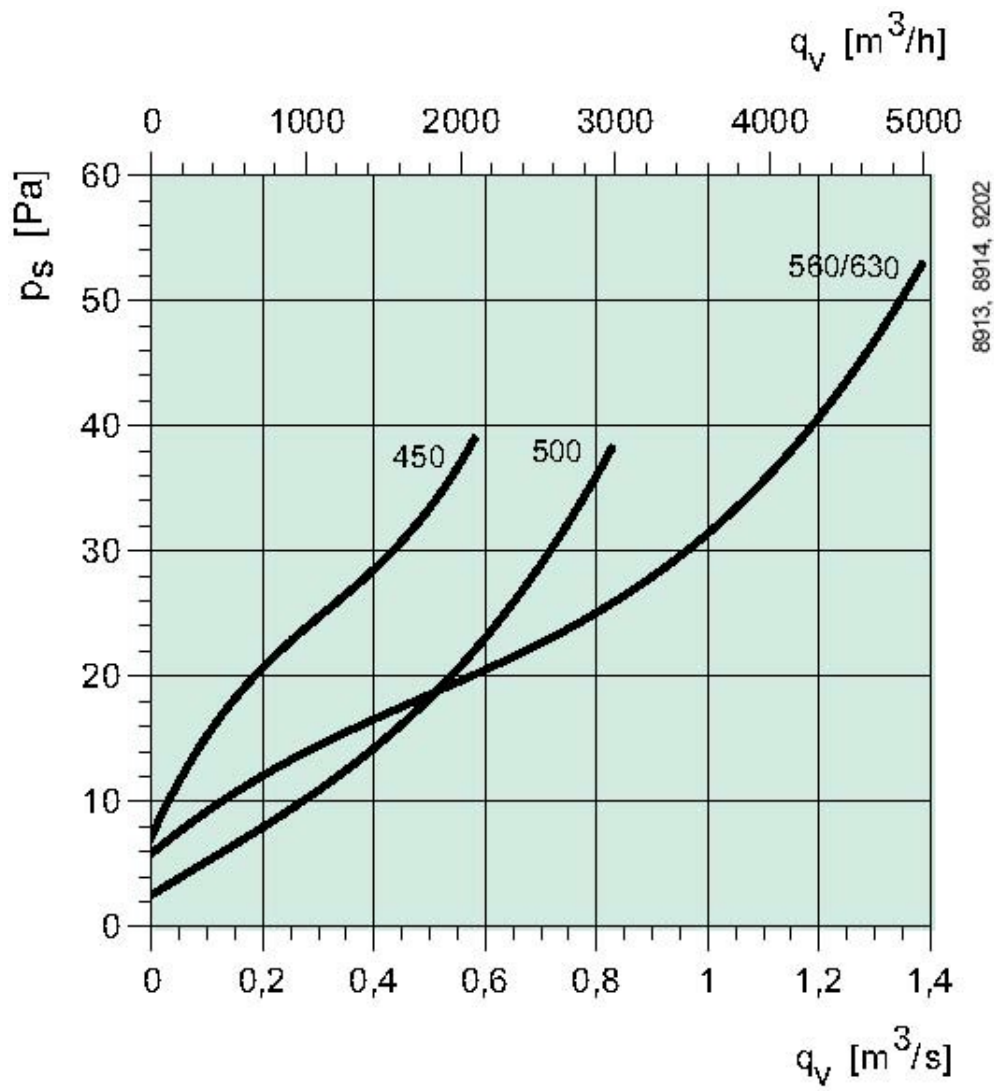

Specification text