

SDS 310/311 SLANT. ROOF SOCKET

Item no. 3784

Document type: **Product card**
Document date: **2019-06-24**
Generated by: **Systemair Online Catalogue**

Description

the SDS is manufactured from seawater resistant aluminium and supplied with mounting material ready for assembly.
Suitable for DVS/DHS, DVSI, DVN, DVNI, DVC, DVEX.



Dimensions

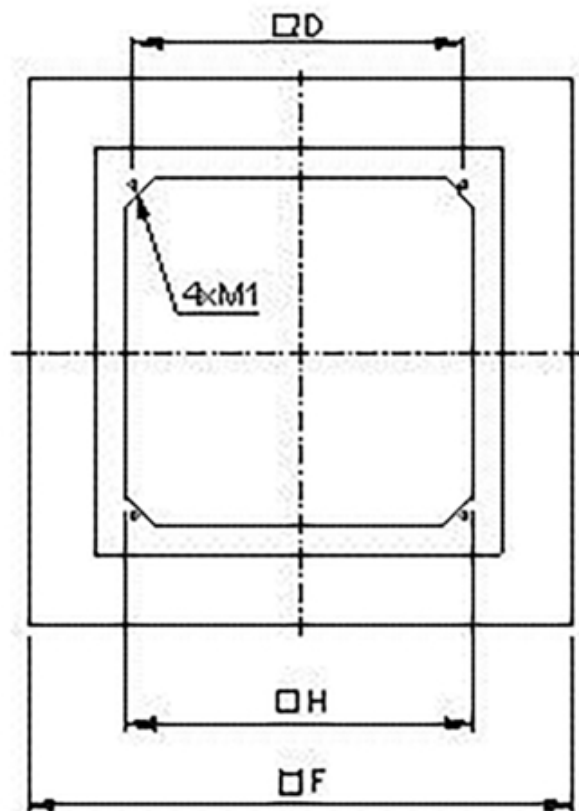
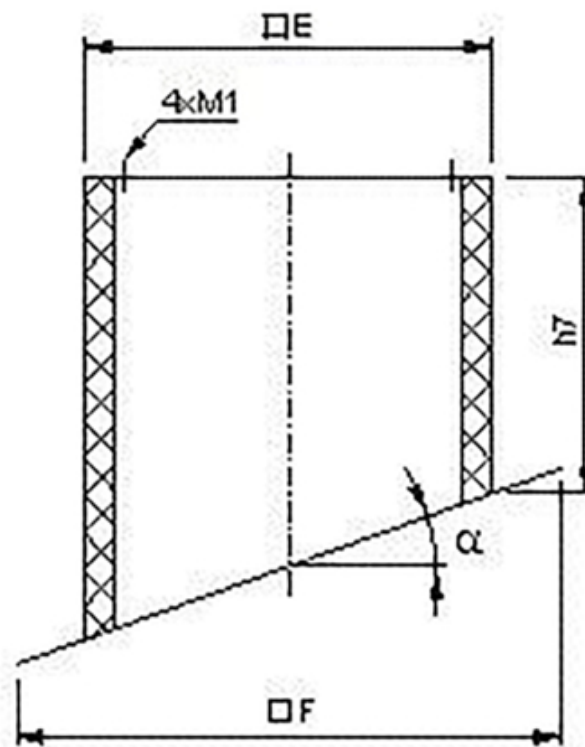

	D	E	F	H	nut M1	h7	weight (kg)	
							$\alpha = 10^\circ$	$\alpha = 30^\circ$
SDS 190/225*	245	294	571	258	M6	300	3	4
SDS310/311**	330	395	710	345	M6	300	6	7
SDS 355/400	450	555	874	505	M10	300	8	10
SDS 450/500	535	625	900	565	M10	300	10	14
SDS 560/630	750	895	1200	835	M10	300	15	23
SDS 710	840	985	1300	925	M10	300	16	26

* also suitable for TFSK 125 M/L

** also suitable for TFSK 160 and 200

Weights only for 10° respectively 30° roof angle for information only.

At order it is necessary to know the roof angle α (from 1° to 45°)!

Accessories

Documentation

Specification text