

SPM-200 IRIS DAMPER WITH BULB

Item no. 6253

Document type: **Product card**
 Document date: **2019-06-20**
 Generated by: **Systemair Online Catalogue**

Description

Systemair SPM iris damper with more choking ability.

Function

The SPM is an iris damper for measuring and adjusting the air flow, with more choking ability than the SPI. The SPM has the following specifications: low noise level, centrally formed air flow and fixed test points for precise measurements. Accessorie, Access door RLL, is recommended for use with SPM. Available in sizes \varnothing 160-400, but not for size 300.

Design

The damper is manufactured from galvanised sheet steel and is fitted with an air-tight rubber seal. Size \varnothing 160-400.

How to use for exhaust air

This device can be used for exhaust air.

Mounting

The SPM adjustment damper must be installed in accordance with the distances required to minimise air-flow deviation. Reducing or enlarging the duct to the next duct size does not require any specified distances for minimising deviation. The SPM enables the taking of precise air-flow measurements at all points including points close to duct deviations such as T junctions and bends, and points in front of other supply-air devices.

Protective distance

- before bends 1 x D
- after " 1 x D
- before T-pipes 3 x D
- after " 1 x D
- before supply-air devices 3 x D

Accessories

Dimensions

	$\varnothing d$	C	$\varnothing D$
SPM 160	159	60	230
SPM 200	199	62	285
SPM 250	249	62	333
SPM 300	299	63	406
SPM 315	314	63	406
SPM 400	399	70	560

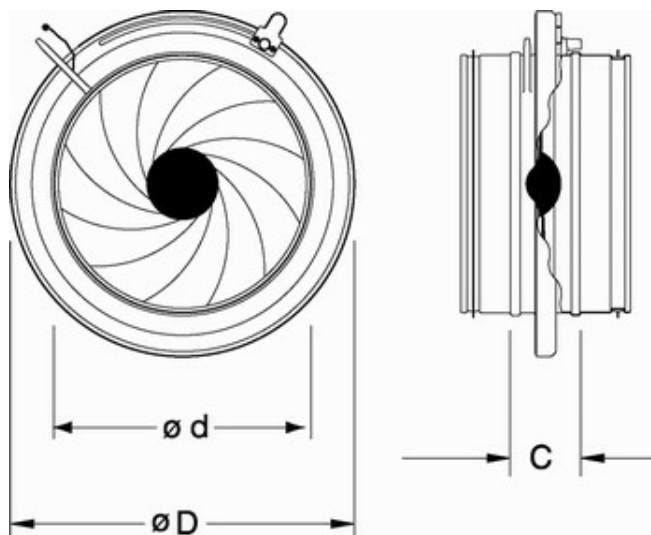

Documentation



Diagram

Mid-frequency band, Hz

	63	125	250	500	1K	2K	4K
SPM 160	9	6	1	-5	-11	-18	-27
SPM 200	9	5	1	-5	-12	-17	-24
SPM 250	6	1	-4	-3	-12	-17	-24
SPM 315	3	1	-4	-4	-9	-14	-23
SPM 400	3	1	-4	-4	-9	-13	-19
Tolerance	±6	±5	±2	±2	±2	±2	±3

