

SWF3 FILTER DETAIL

Item no. 10117

Document type: **Product card**
 Document date: **2019-06-19**
 Generated by: **Systemair Online Catalogue**

Description

SWF, filter section

Filters the outdoor air or/and return air from particles that might reduce the performance and reliability of SWH. The disposable deep-pleated bagfilter is a cassette of synthetic material. Filterclass G85 (EU3). The filter section is equipped with filter on delivery.

Note! If the filter section is not used in combination with the mixing cabinet, a return air intake (SWD) is required.

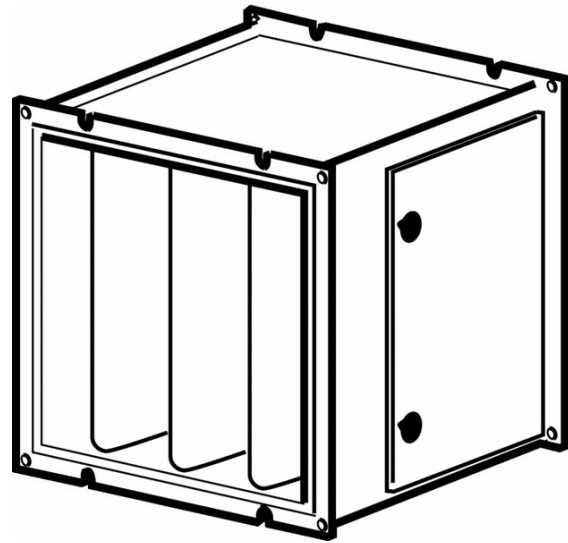



Technical parameters

Unit		
Length	746	mm
Height	722	mm
Depth	524	mm
X-Color	RAL 9016, NCS S 0500-N	W/(l/s)

Accessories

Documentation

 [Wiring diagram, internal PTRP-CBT.pdf \(195,78kB\)](#)

 [Wiring diagram, internal PTRP-TIM.pdf \(167,28kB\)](#)