

VK-50-25 LOUVRE SHUTTER

Item no. 5647

Document type: **Product card**
 Document date: **2019-05-15**
 Generated by: **Systemair Online Catalogue**

Description

Louvre shutters for vertical mounting on a wall. The profiled vanes produce a strong upward force which reduces the air resistance. This means that the vanes opens fully at low air velocities as well. All the parts are manufactured in weather-resistant and shockproof nylon material (PVC containing special synthetic). The robust construction ensures that the blades will not become deformed or loose. Air velocity should not exceed 12 m/s. The louvre shutters are easy to install. Wall plugs and screws are included.



Dimensions

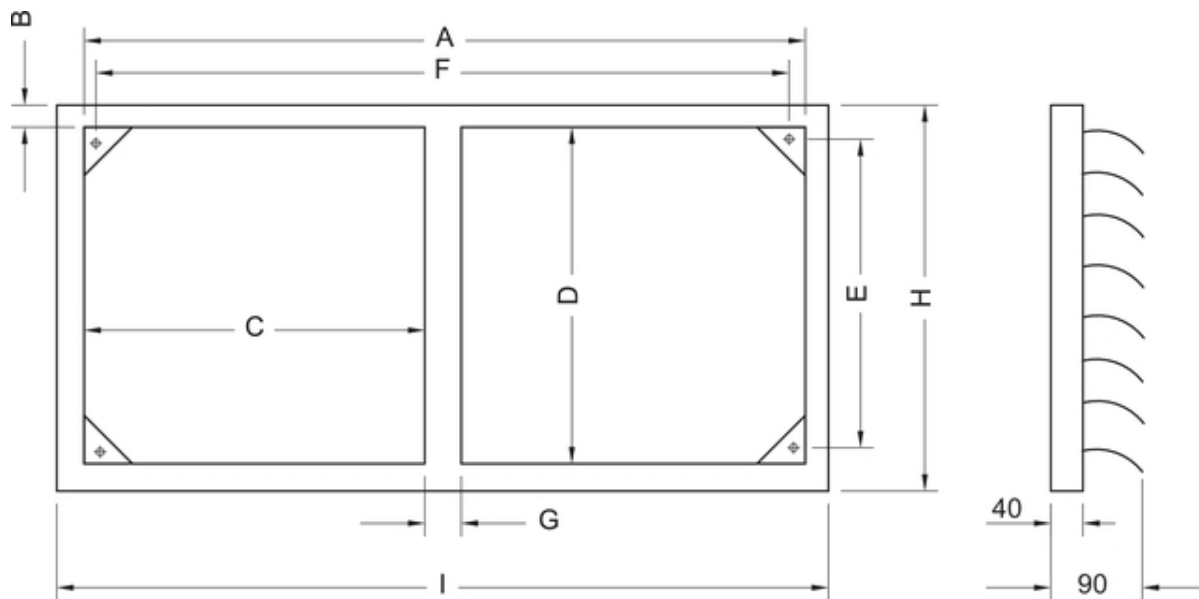

	A	B	C	D	E	F	G	H	I
VK 40-20	457	14	454	257	207	407	-	285	485
VK 50-25	557	14	552	305	265	515	-	335	585
VK 50-30	557	14	554	357	307	507	-	385	585
VK 60-30	657	14	2x311,5	357	307	607	28	385	685
VK 60-35	657	14	2x311,5	407	357	607	28	435	685
VK 70-40	757	14	2x361,5	457	407	707	30	485	785
VK 80-50	848	14	2x407	557	507	798	28	585	876
VK 100-50	1148	14	2x557	557	507	1098	28	585	1176

Documentation

Diagram

...

