

# VKGM 560 MOTOR. SHUTTER DVV

Item no. 95506

Document type: **Product card**  
 Document date: **2019-05-15**  
 Generated by: **Systemair Online Catalogue**

## Description

### VKGM motor driven shutter for DVV-XS....XL/120

Suitable for the roof fans DVV-XS...XL/120. Temperature of use up to app. 70°C.  
 Made of Magnelis steel. With direct coupled 230V/50Hz ON-OFF spring return actuator (NF230A). The flap opens when applying supply voltage. If the power supply is interrupted, the flap closes. Manually operating possible. Actuator equipped with auxiliary switches is available upon request.



#### Technical data:

Power consumption in operation: up to 6W  
 Power consumption for wire sizing: 9,5 VA  
 Connection: cable 2x0,75 mm<sup>2</sup>, 1m  
 Running time: opening <75s, closing <20s  
 Degree of protection: IP54  
 Ambient temperature: -30.....+50°C  
 Maintenance free.

## Dimensions

		ø d	ø d1	ø d2	n x ø d3	A	B	C	D	H	kg
VKGM 560	pitch diameter 1 (Eurovent)	560	620	641,5	12x12	222	42	235	393	290	18
	pitch diameter 2		605		16x12						
VKGM 630	pitch diameter 1 (Eurovent)	630	690	721,5	12x12	257	77	235	428	290	21
	pitch diameter 2		674		16x12						
VKGM 800/1000	pitch diameter 1 (Eurovent)	800	860	901,5	16x12	342	102	295	513	350	32
	pitch diameter 2		872		8x12						

2 pitch diameters

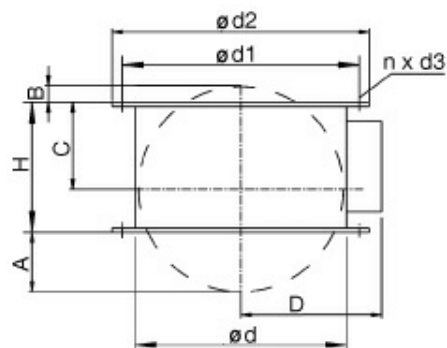

## Wiring

### Wiring diagram

#### Notes

- Caution: Power supply voltage!
- Parallel connection of other actuators possible.  
Note the performance data.

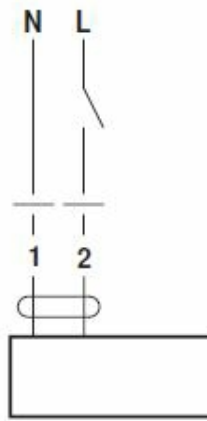

#### Cable colours:

- 1 = blue
- 2 = brown

## CAD drawing



VKGM\_560\_00.dxf (744,42kB)