

WSD KBR-1 WEATHER ROOF F.MOTOR

Item no. 2728

Document type: **Product card**
Document date: **2019-05-08**
Generated by: **Systemair Online Catalogue**

Description

Weather roof for motor

Additional weather protection for the motor if mounted outside. Manufactured from seawater resistant aluminium.

Suitable for KBT 160 - 180, KBR 315/355 4-pole.



Technical parameters

Other	
Weight	0,6 kg

Dimensions

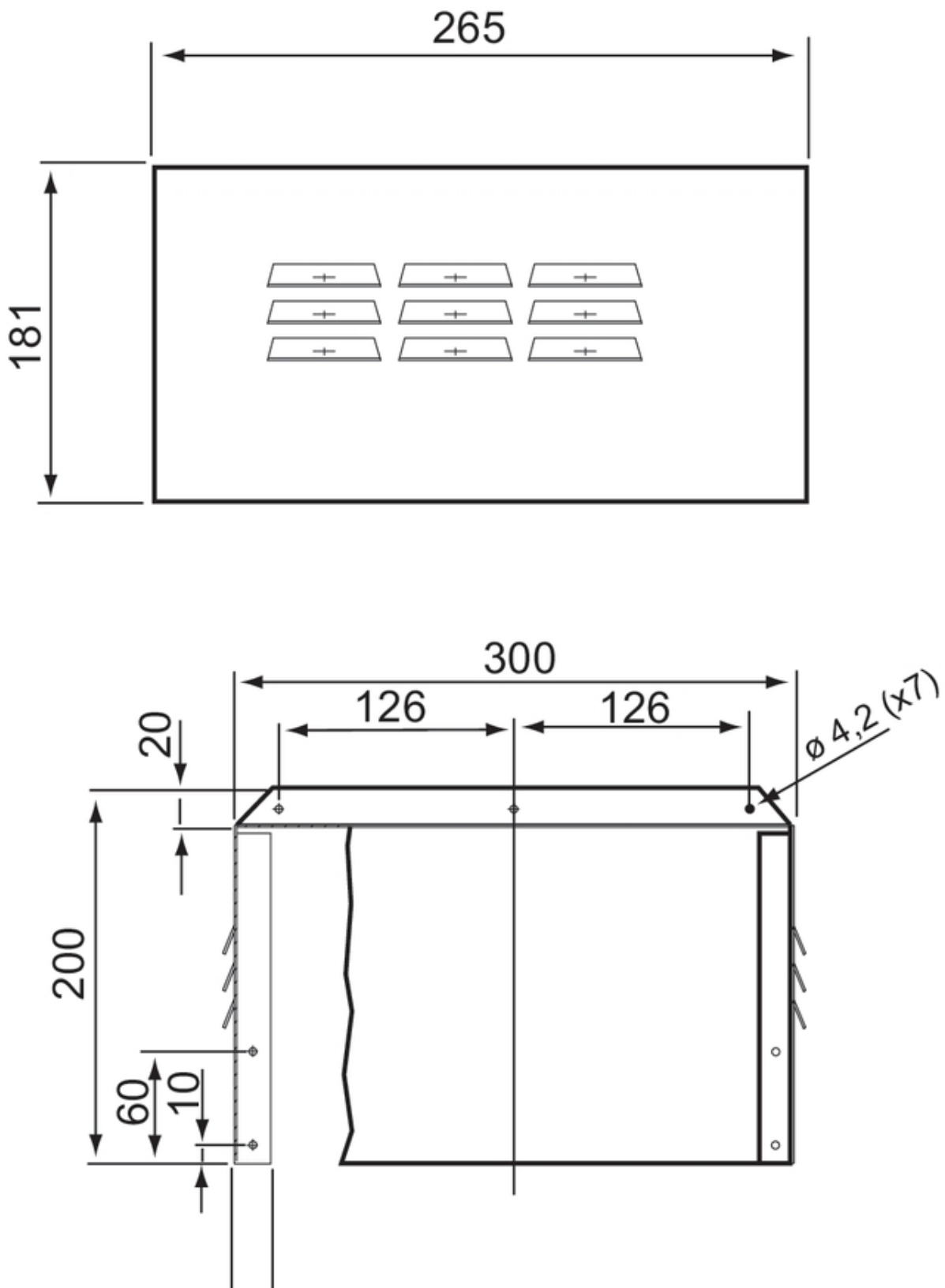

Accessories

Documentation